

DESCRIPTION

The LX5503 is a power amplifier optimized for the FCC Unlicensed National Information Infrastructure (U-NII) band and HiperLAN2 applications in the 5.15-5.85GHz frequency range. The PA is implemented as a two-stage monolithic microwave integrated circuit (MMIC) with active bias and input/output pre-matching. The device is manufactured with an InGaP/GaAs Heterojunction Bipolar Transistor (HBT) IC process (MOCVD). It operates at a single low voltage supply of 3.3V with +25dBm of P1dB and 22dB power gain between 5.15-5.35GHz and 18dB gain up to 5.85GHz.

For +18dBm OFDM output power (64QAM, 54Mbps), the PA provides a very low EVM (Error-Vector Magnitude) of 4%, and consumes less than 200mA total DC current.

The LX5503 is available in a 16-pin 3mmx3mm micro-lead package (MLP). The compact footprint, low profile, and excellent thermal capability of the MLP package makes the LX5503 an ideal solution for broadband, medium-gain power amplifier requirements for IEEE 802.11a, and Hiperlan2 portable WLAN applications.

IMPORTANT: For the most current data, consult MICROSEMI's website: <http://www.microsemi.com>

KEY FEATURES

- Advanced InGaP HBT
- 5.15-5.85GHz Operation
- Single-Polarity 3.3V Supply
- Low Quiescent Current I_q ~100mA
- P1dB ~ +25dBm across 5.15~5.85GHz
- Power Gain ~ 22dB at 5.25GHz & Pout=18dBm
- Power Gain ~ 18dB at 5.85GHz & Pout=18dBm
- Total Current < 200mA for Pout=18dBm
- EVM ~ 4% for 64QAM/ 54Mbps & Pout=18dBm
- Excellent Temperature Performance
- Simple Input/Output Match
- Minimal External Components
- Small Footprint: 3x3mm²
- Low Profile: 0.9mm

APPLICATIONS/BENEFITS

- FCC U-NII Wireless
- IEEE 802.11a
- HiperLAN2

PRODUCT HIGHLIGHT

PACKAGE ORDER INFO

T _J (°C)	LQ	Plastic 16-Pin
-40 to 85		LX5503-LQ

Note: Available in Tape & Reel (3K parts per reel).
 Append the letter "T" to the part number.
 (i.e. LX5503-LQT)

This device is classified as ESD Level 1 in accordance with MIL-STD-883, Method 3015 (HBM) testing. Appropriate ESD procedures should be observed when handling this device.

ABSOLUTE MAXIMUM RATINGS

DC Supply Voltage, RF off.....	6V
Collector Current.....	500mA
Total Power Dissipation.....	3 W
RF Input Power.....	10dBm
Operation Ambient Temperature.....	-40 to +85°C
Storage Temperature.....	-60 to +150°C

Note: Exceeding these ratings could cause damage to the device. All voltages are with respect to Ground. Currents are positive into, negative out of specified terminal.

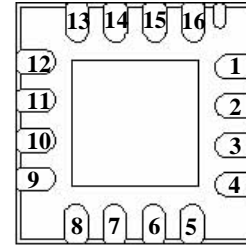
PACKAGE PIN OUT

LQ PACKAGE
(Bottom View)

FUNCTIONAL PIN DESCRIPTION

Pin Name	Pin Number	Description
RF IN	2, 3	RF input for the power amplifier. This pin is DC-shorted to GND but AC-coupled to the transistor base of the first stage. For 5.15-5.35GHz this pin is pre-matched to 50Ω.
Vb1	6	Bias current control voltage for the first stage.
Vb2	7	Bias current control voltage for the second stage. The VB2 pin can be connected with the first stage control voltage (VB1) into a single reference voltage (referred to as Vref) through an external resistor bridge(R1/R2).
Vcc	9	Supply voltage for the bias reference and control circuits. The VCC feed line should be terminated with a 1 μF bypass capacitor as close to the device as possible. This pin can be combined with both VC1 and VC2 pins, resulting in a single supply voltage (referred to as Vc).
RF OUT	10, 11	RF output for the power amplifier. This pin is AC-coupled and does not require a DC-blocking capacitor.
Vc1	15	Power supply for first stage amplifier. The VC1 feedline should be terminated with a 220pF bypass capacitor as close to the device as possible, followed by a 1 μF bypass capacitor at the supply side. This pin can be combined with VC2 and VCC pins, resulting in a single supply voltage (referred to as Vc).
Vc2	14	Power supply for second stage amplifier. The VC2 feedline should be terminated with a 220pF bypass capacitor as close to the device as possible, followed by a 1 μF bypass capacitor at the supply side. This pin can be combined with VC1 and VCC pins, resulting in a single supply voltage (referred to as Vc).
GND		The center metal base of the MLP package provides both DC and RF ground as well as heat sink for the power amplifier.

ELECTRICAL CHARACTERISTICS

 Test conditions: $V_{cc}=3.3V$, $V_{ref}=2.86V$, $I_{cq}=100mA$, $T_A=25^{\circ}C$.

Parameter	Condition	Symbol	Min.	Typ.	Max.	Min.	Typ.	Max.	Unit
Frequency Range		f	5.15		5.35	5.7		5.85	GHz
Output Power at 1dB Compression		Pout	24	25		24	25		dBm
Power Gain at Pout=18dBm		Gp	20	22		16	18		dB
EVM at Pout=18dBm	64QAM/54Mbps			4			4		%
Total Current at Pout=18dBm		Ic_total		200			180		mA
Quiescent Current		Icq		100			100		mA
Bias Control Reference Current	For Icq=100mA	Iref		1.6			1.6		mA
Small-Signal Gain		S21		21			17		dB
Gain Flatness	Over 100MHz	$\Delta S21$		+/-0.2			+/-0.5		dB
Gain Variation Over Temperature	-40 to +85°C	$\Delta S21$		+/-1			+/-1		dB
Input Return Loss		S11		-15	-10		-12	-10	dB
Output Return Loss		S22		-9			-10		dB
Reverse Isolation		S12		-40			-40		dB
Second Harmonic	Pout = 18dBm			-45			-42		dBc
Third Harmonic	Pout = 18dBm			-37			-37		dBc
Noise Figure		NF		6			6		dB
Ramp-On Time	10~90%	tON		100			100		ns

Note: All measured data was obtained on a 5 mil GETEK evaluation board without heat sink.

CHARTS

Typical Power Sweep Data at Room Temperature

($V_c=3.3V$, $V_{ref}=2.86V$, $I_{cq}=100mA$)

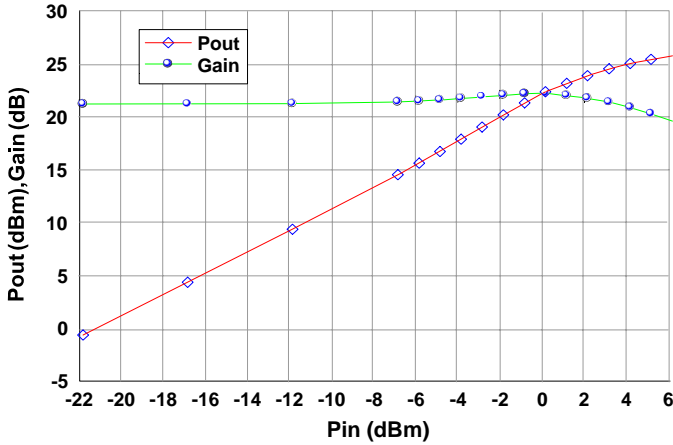

Freq.=5.15GHz

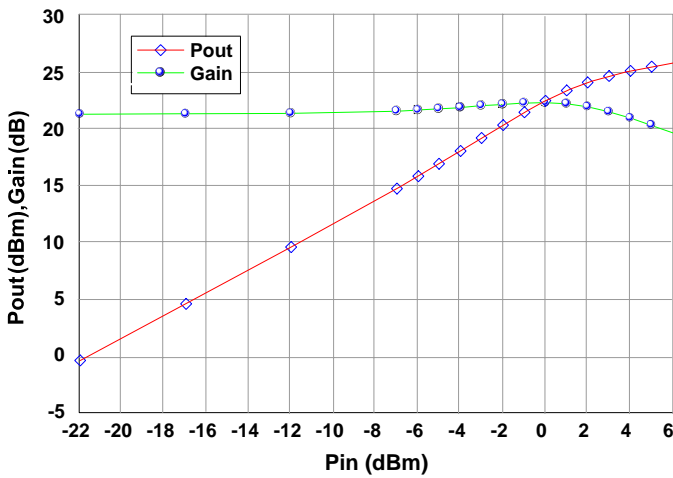

Freq.=5.25GHz

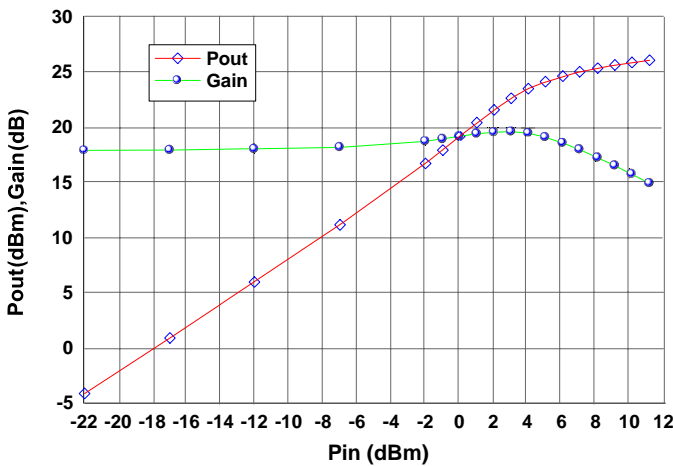

Freq.=5.85GHz

CHARTS

Typical EVM & Total Current vs. Output Power
(Vc=3.3V, Vref=2.86V, Icq=100mA, 64QAM/54Mbps)

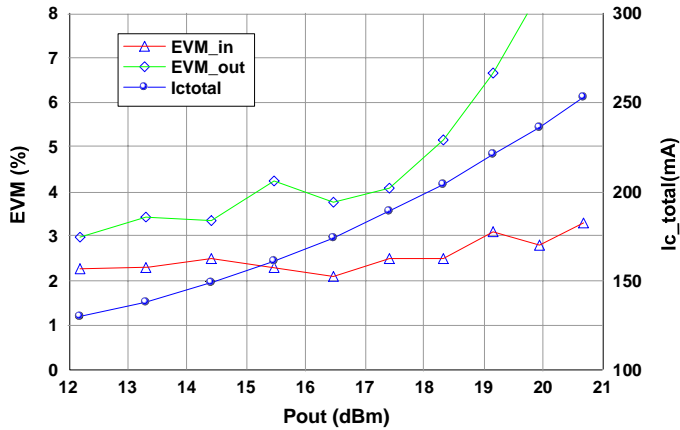

Freq.=5.15GHz

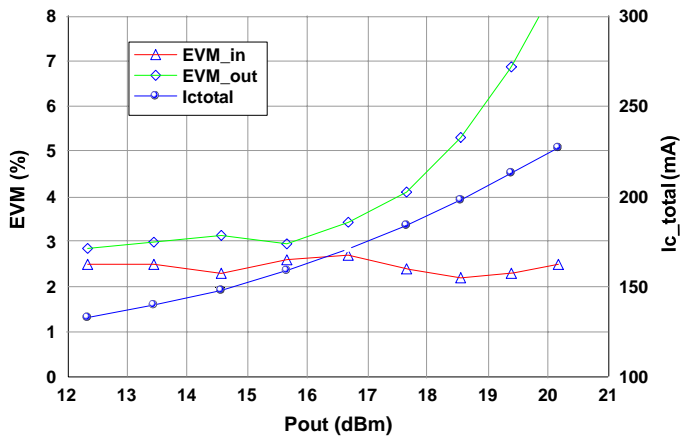

Freq.=5.25GHz

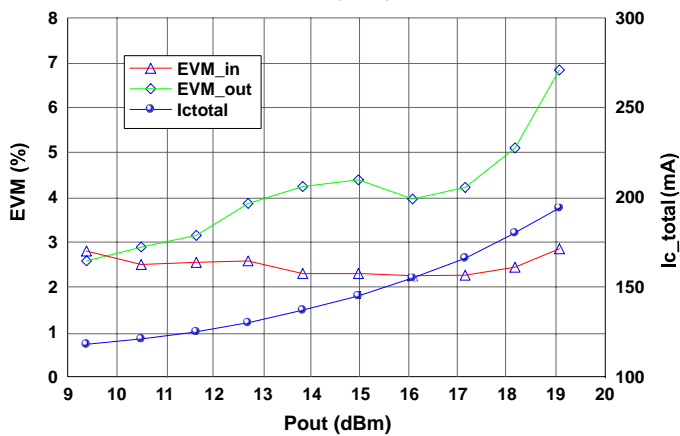

Freq.=5.85GHz

CHARTS

Typical S-Parameter Data at Room Temperature

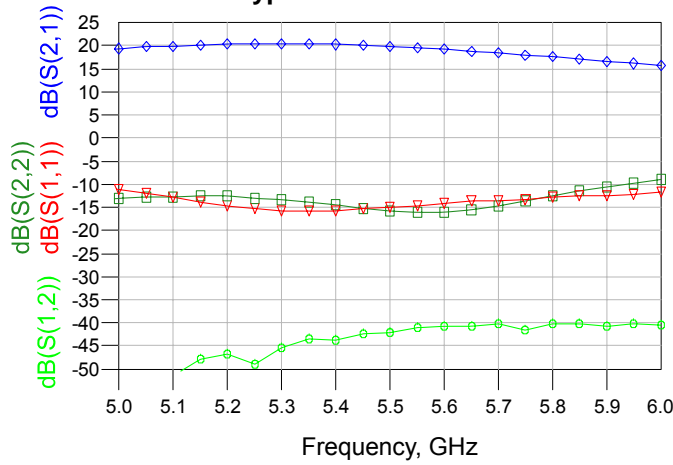

Vc=3.3V
Vref=2.81V
Icq=80mA

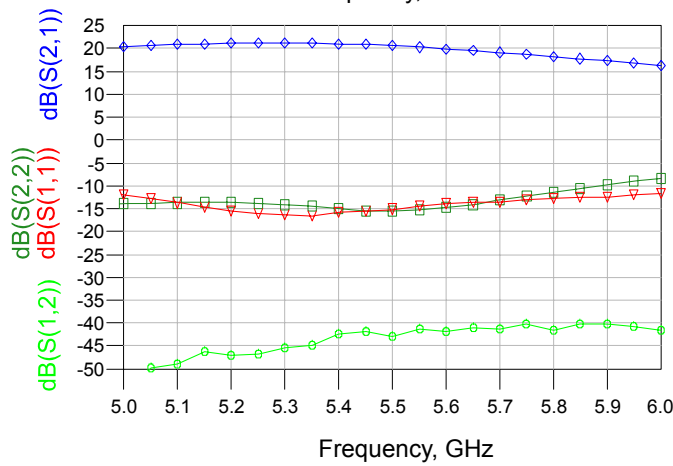

Vc=3.3V
Vref=2.86V
Icq=100mA

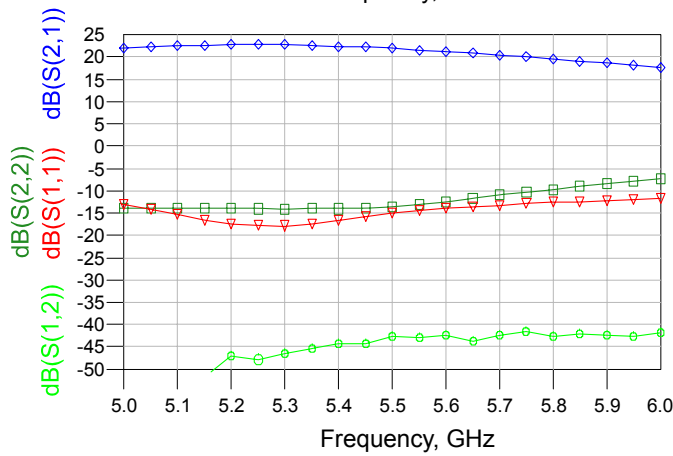

Vc=3.3V
Vref=2.98V
Icq=160mA

CHARTS

Quiescent Current vs. Vref
($V_{C1}=V_{C2}=V_{CC}=V_c=3.3V$)

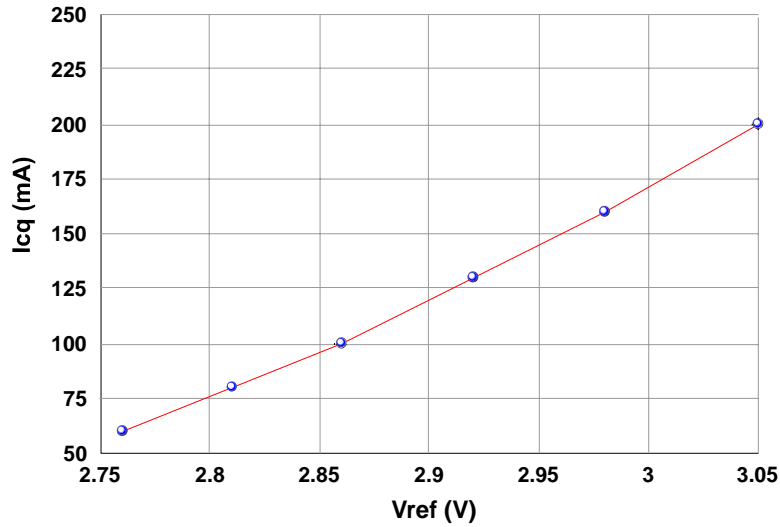

Power Down Isolation
($V_c=3.3V$, $V_{ref}=0$ to $1V$, $I_{cq}<2\mu A$)

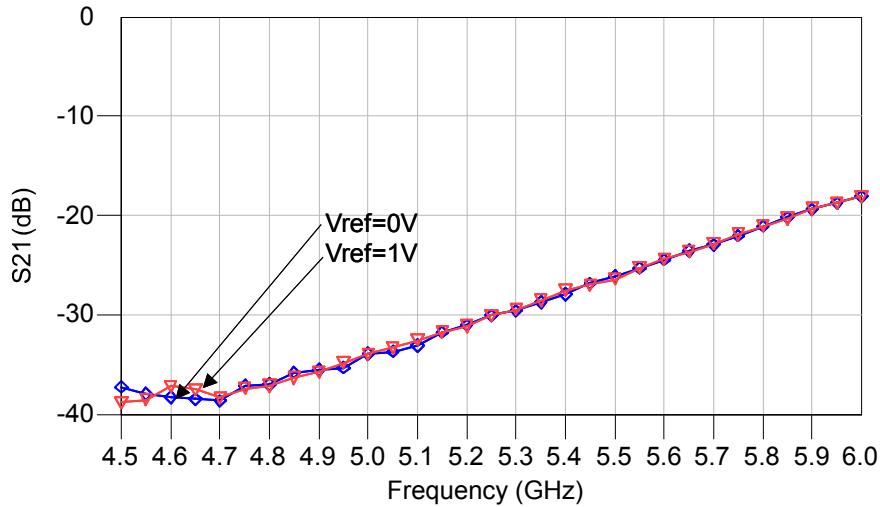

CHARTS

Power, EVM & Current for Low Quiescent Current
(Recommended for High Efficiency Operation)
(Vc=3.3V, Vref=2.81V, Icq=80 mA, Freq.=5.25GHz)

Power & Gain vs. Pout

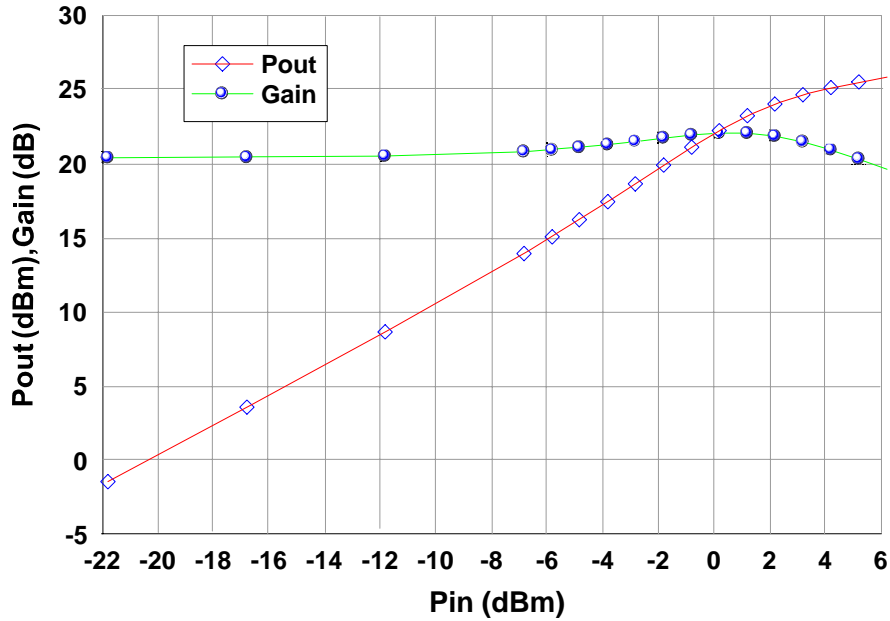

EVM & Total Current vs. Pout

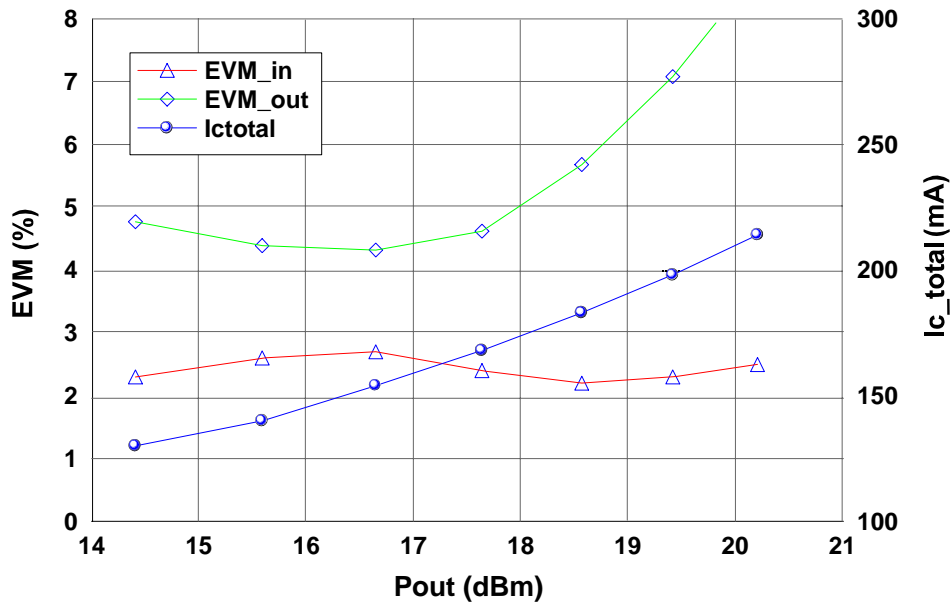

CHARTS

Power, EVM & Current for High Quiescent Current
 (Recommended for High Gain Operation)
 (Vc=3.3V, Vref=2.98V, Icq=160 mA, Freq.=5.25GHz)

Power & Gain vs. Pout

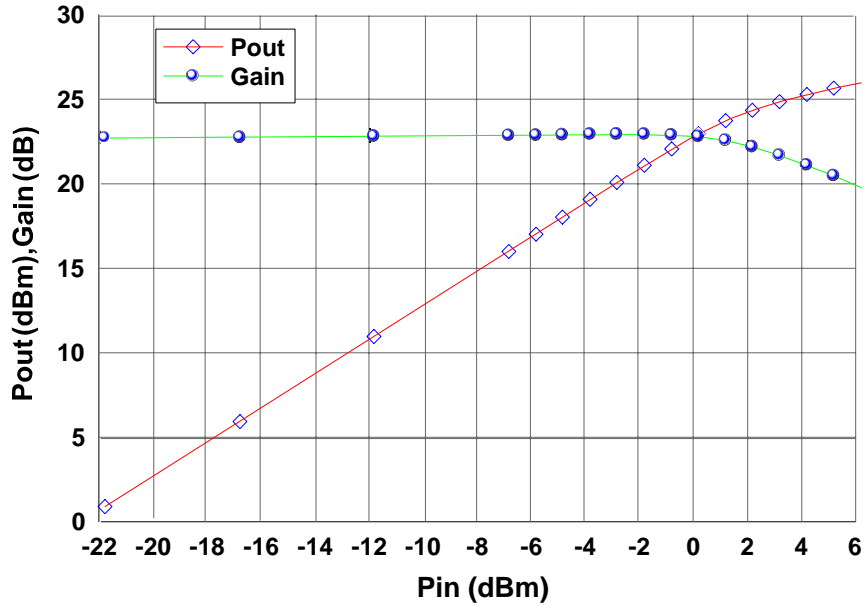

EVM & Total Current vs. Pout

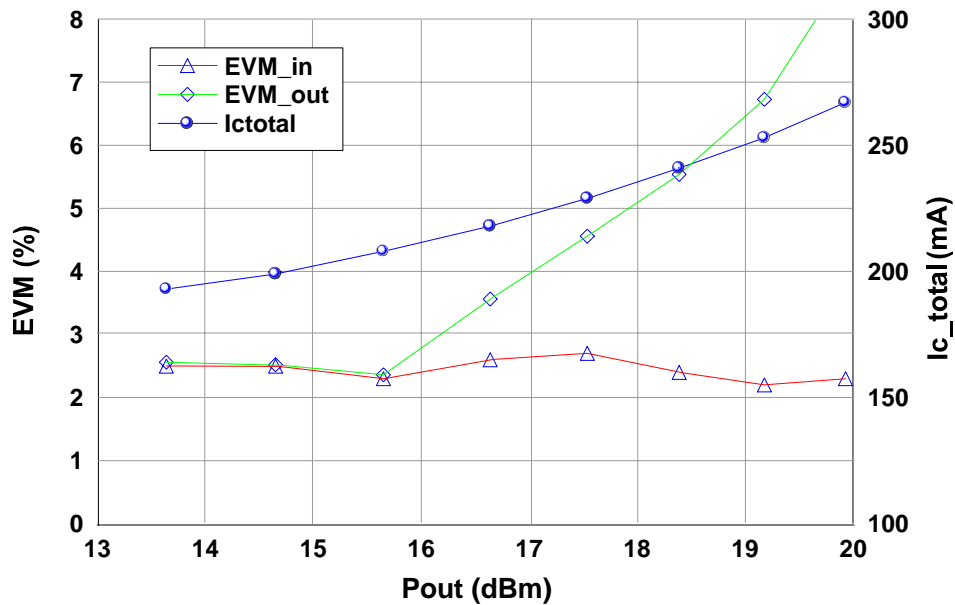

CHARTS

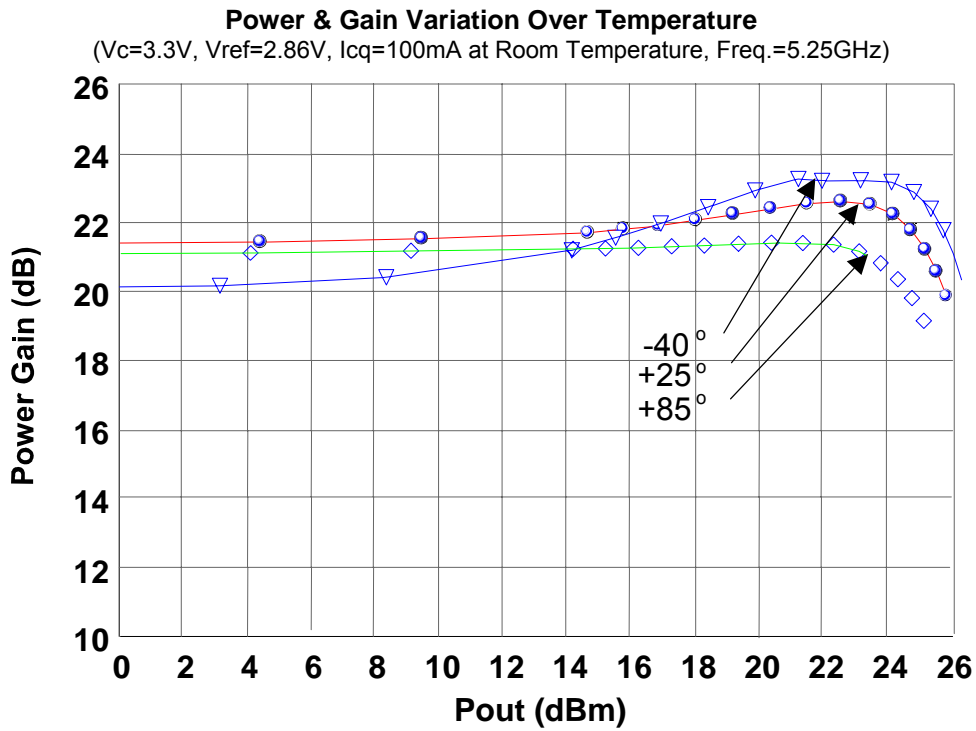
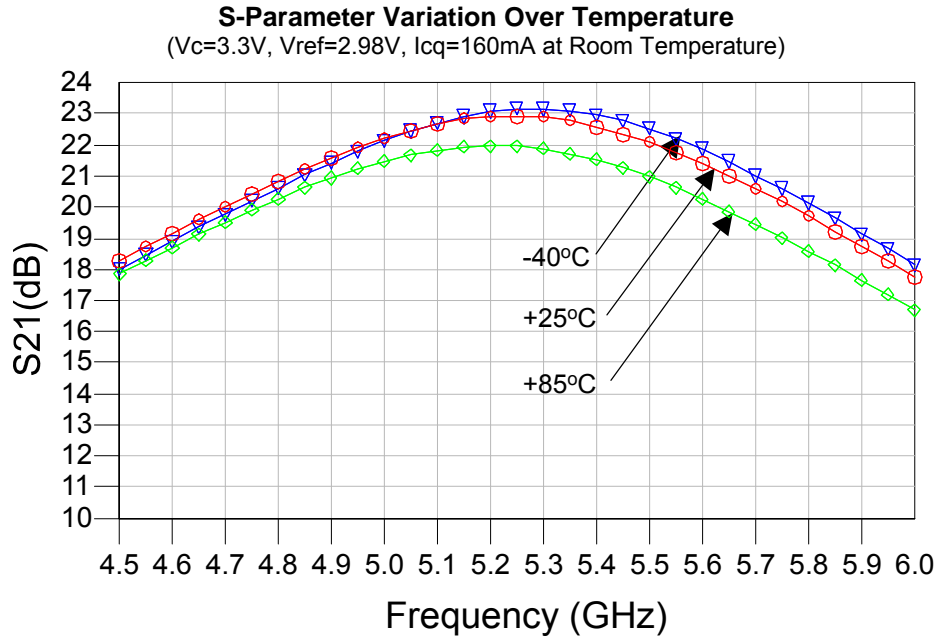

CHARTS

Small-Signal Gain vs. Supply Voltage

(Vref=2.86V, Icq=100mA for Vc=3.3V)

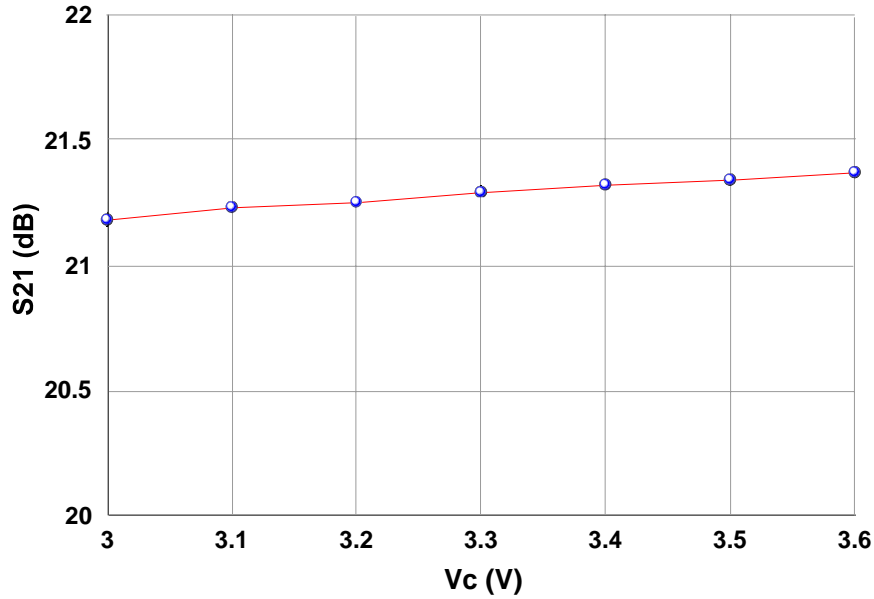

P1dB vs. Supply Voltage

(Vref=2.86V, Icq=100mA for Vc=3.3V)

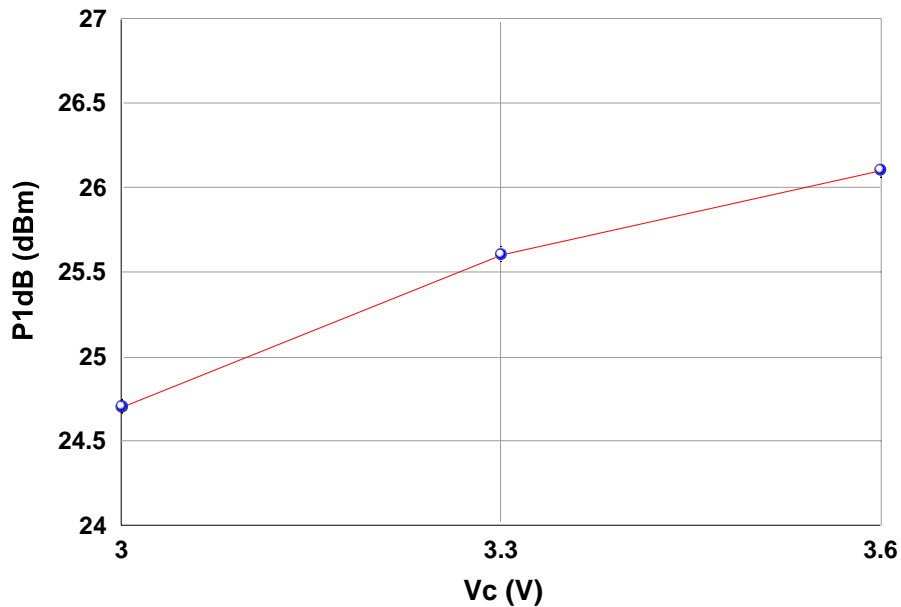

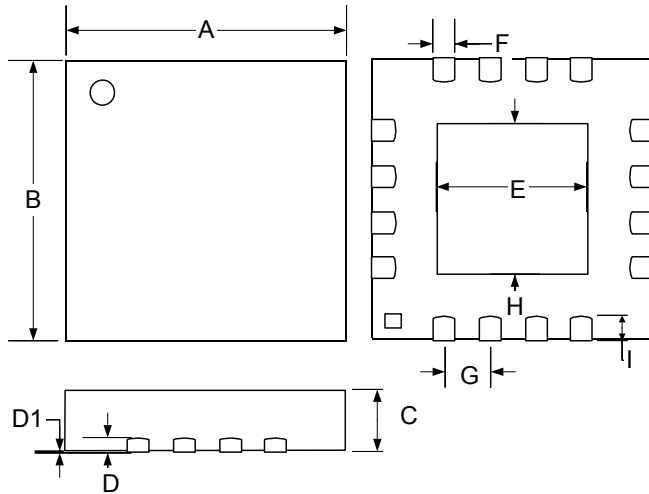
MECHANICAL DRAWING
LQ 16-Pin MLPQ Plastic (3x3mm EP)

Dim	MILLIMETERS		INCHES	
	MIN	MAX	MIN	MAX
A	3.00 BSC		0.118 BSC	
B	3.00 BSC		0.118 BSC	
C	0.80	1.00	0.031	0.039
D	0.18	0.30	0.007	0.011
D1	0	0.05	0	0.002
E	1.30	1.55	0.051	0.061
F	0.18	0.30	0.007	0.011
G	0.50 BSC		0.019 BSC	
H	1.30	1.55	0.051	0.061
I	0.30	0.50	0.011	0.020

Note:

- Dimensions do not include mold flash or protrusions; these shall not exceed 0.155mm(.006") on any side. Lead dimension shall not include solder coverage.

NOTES

PRODUCTION DATA – Information contained in this document is proprietary to Microsemi and is current as of publication date. This document may not be modified in any way without the express written consent of Microsemi. Product processing does not necessarily include testing of all parameters. Microsemi reserves the right to change the configuration and performance of the product and to discontinue product at any time.